

GP Batteries

Data Sheet

Model No.: GP60AAS

Type	: Rechargeable Nickel Cadmium Cylindrical Cell	
Nominal Dimension (with Sleeve)	: $\Phi = 14.4\text{mm}$ H = 48.2mm	
Applications	: Recommended discharge current 30 to 1800mA	
Nominal Voltage	: 1.2V	
Capacity	: Minimum: 600mAh Typical: 660mAh when discharged at 120mA to 1.0V at 20°C	
Charging Condition	: 60mA for 16 hrs at 20°C	
Fast Charge	: 300mA to 600mA (0.5 to 1C) with charge termination control Recommended control parameters: - ΔV : 10 - 20mV Timer : 120% nominal input	
Service Life	: >500 cycles (IEC standard)	
Continuous Overcharge	: 60mA maximum current for 1 year No conspicuous deformation and/or leakage	
Weight	: 18.0g	
Internal Resistance	: Average 39m Ω upon fully charged (Range 30-45m Ω) at 1000Hz	
Max. Charging Voltage	: 1.5V at 60mA charging	
Ambient Temperature Range	Standard Charging	: 0 to 45°C
	Fast Charging	: 10 to 45°C
	Discharging	: -20 to 50°C
	Storage	: -20 to 35°C

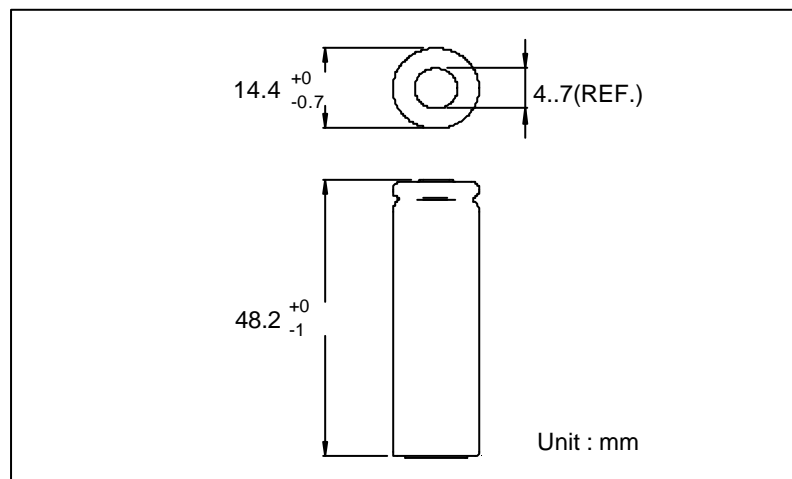

Fast Charge (Charge control required)

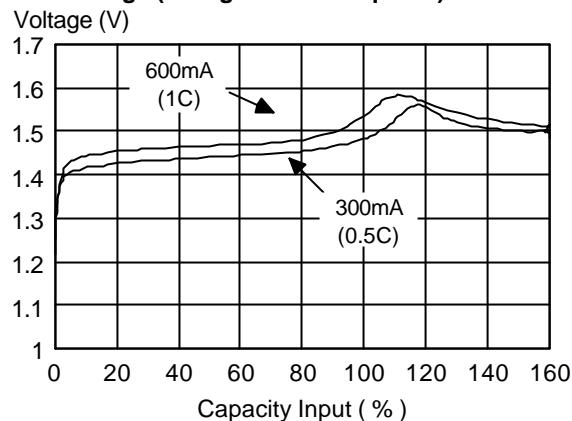

Low Rate Discharge

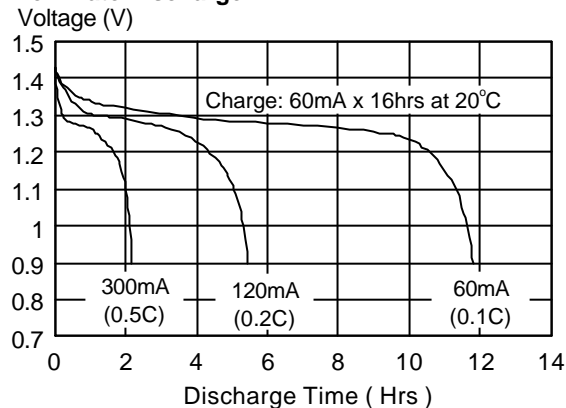

High Rate Discharge

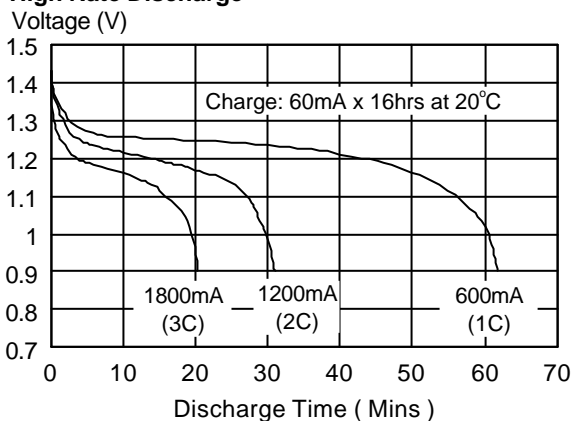

* The information (subject to change without prior notice) contained in this document is for reference only and should not be used as a basis for product guarantee or warranty. For applications other than those described here, please consult your nearest GP Sales and Marketing Office or Distributors.